

MultiPlus-II 120V

Table of Contents

1. IMPORTANT SAFETY INSTRUCTIONS - Save these instructions!	1
2. Description	3
2.1. Boats, vehicles and other stand-alone applications	3
2.2. On-grid and off-grid systems combined with PV	3
2.3. Battery charger	4
2.3.1. Lead-acid batteries	4
2.3.2. Second charge output for starter battery	4
2.3.3. Victron Lithium Battery Smart	5
2.3.4. Other lithium batteries	5
2.3.5. More on batteries and battery charging	5
2.4. ESS – Energy Storage Systems: feeding energy back into the grid*	5
3. Operation	6
3.1. On/Off/Charger Only Switch	6
3.2. Remote control	6
3.3. Equalisation and forced absorption	6
3.3.1. Equalisation	6
3.3.2. Forced absorption	6
3.3.3. Activating equalisation or forced absorption	6
3.4. LED Indications	7
3.5. Shut down procedure	10
3.6. Maintenance	10
4. Installation	11
4.1. Location	11
4.2. Vibration management	13
4.3. Connection of battery cables	13
4.4. Connection of the AC cabling	14
4.5. Optional Connections	15
4.5.1. Remote Control	15
4.5.2. Programmable relay	15
4.5.3. Programmable I/O ports	15
4.5.4. Starter battery	15
4.5.5. Voltage sense	15
4.5.6. Temperature sensor	15
4.5.7. Parallel connection	16
4.5.8. Three-phase connection	16
5. Configuration	17
5.1. Standard settings: ready for use	17
5.2. Explanation of settings	17
5.3. Configuring	20
5.3.1. VictronConnect app	20
5.3.2. VEConfigure	20
5.3.3. VE.Bus Quick Configure Setup	20
5.3.4. VE.Bus System Configurator	20
6. Error Indications	21
6.1. General error indications	21
6.2. Special LED indications	22
6.3. VE.Bus LED indications	23
6.3.1. VE.Bus OK codes	23
6.3.2. VE.Bus error codes	23
7. Technical specifications	26
8. Appendix	31
8.1. A: Connection overview	31
8.2. B: Block diagram	34

8.3. C: Parallel connection diagram	34
8.4. D: Three-phase connection diagram	35
8.5. E: Charge algorithm	35
8.6. F: Temperature compensation chart	36
8.7. G: Enclosure dimensions	37

1. IMPORTANT SAFETY INSTRUCTIONS - Save these instructions!

In general

Please read the documentation supplied with this product first, so that you are familiar with the safety signs and directions before using the product.

SAVE THESE INSTRUCTIONS — THIS MANUAL CONTAINS IMPORTANT SAFETY INSTRUCTIONS

This product is designed and tested according to international standards. The equipment should be used only for the designated application.



Warning – These servicing instructions are for use by qualified personnel only. To reduce the risk of electric shock, do not perform any servicing other than that specified in the operating instructions unless you are qualified to do so



The product is used in combination with a permanent energy source (battery). A dangerous electrical voltage can occur at the input and/or output terminals, even if the equipment is switched off. Always turn off the AC power and disconnect the battery before performing maintenance.

The product contains no internal user-serviceable parts. Do not remove the front panel, and do not put the product into operation unless all panels are fitted. All maintenance should be performed by qualified personnel. Internal fuses are not user-replaceable. A unit with suspected blown fuses should be taken to an authorized service centre for evaluation.

Never use the product at sites where gas or dust explosions could occur. Refer to the specifications provided by the manufacturer of the battery to ensure that the battery is suitable for use with this product. The battery manufacturer's safety instructions should always be observed.

This appliance is not intended for use by persons (including children) with reduced physical, sensory or mental capabilities, or lack of experience and knowledge unless they have been given supervision or instruction concerning the use of the appliance by a person responsible for their safety. Children should be supervised to ensure they do not play with the appliance.



Do not lift heavy objects unassisted.

Installation

Read the installation instructions before commencing installation activities. Follow the local national wiring standards, regulations, and installation instructions for electrical work. The installation shall be in accordance with the Canadian Electrical Code, Part 1. The wiring methods shall be in accordance with the National Electrical Code, ANSI/NFPA 70.

This product is a safety class I device (supplied with a ground terminal for safety purposes). **Its AC input and/or output terminals must be provided with uninterruptible grounding for safety purposes. An additional grounding point is located on the product's exterior. The ground conductor should be at least 4mm².** If it can be assumed that the grounding protection is damaged, the product should be taken out of operation and prevented from accidentally being put into operation again; contact qualified maintenance personnel.

Ensure that the connection cables are provided with fuses and circuit breakers. Never replace a protective device with a component of a different type. Refer to the manual for the correct part.

Do not invert neutral and phase when connecting the AC.

Check before switching the device on whether the available voltage source conforms to the configuration settings of the product as described in the manual.

Ensure that the equipment is used under the correct operating conditions. Never operate it in a wet or dusty environment. Ensure that there is always sufficient free space around the product for ventilation and that those ventilation openings are not blocked. Install the product in a heatproof environment. Ensure that there are no chemicals, plastic parts, curtains or other textiles, etc. in the immediate vicinity of the equipment.

This inverter is provided with an internal isolation transformer providing reinforced insulation

Transport and storage





On storage or transport of the product, ensure that the mains supply and battery leads are disconnected.

No liability can be accepted for damage in transit if the equipment is not transported in its original packaging.

Store the product in a dry environment; the storage temperature should range from -20°C to 60°C.

Refer to the battery manufacturer's manual for information on transport, storage, charging, recharging, and disposal of the battery.

Symbol on the enclosure

Symbol	description
	Caution, risk of electric shock
	Refer to the operating instructions
IP21	IP21 Protected from touch by fingers and objects greater than 12mm.
	Alternating Current supply Symbol
	Direct current supply symbol
	Symbol for Equipment grounding conductor.

2. Description

2.1. Boats, vehicles and other stand-alone applications

The basis of the MultiPlus-II is an extremely powerful sine inverter, battery charger and transfer switch in a compact casing.

Important features:

Automatic and uninterruptible switching

In the event of a supply failure or when the generating set is switched off, the inverter/charger will switch over to inverter operation and take over the supply of the connected devices. This is done so quickly that the operation of computers and other electronic devices is not disturbed (Uninterruptible Power Supply or UPS functionality). This makes the inverter/charger highly suitable as an emergency power system in industrial and telecommunication applications.

Two AC outputs

Besides the usual uninterruptible output (AC-out-1), an auxiliary output (AC-out-2) is available that disconnects its load in the event of battery operation. Example: an electric boiler that is allowed to operate only if the genset is running or shore power is available. There are several applications for AC-out-2.

Please enter "AC-out-2" in the search box on our website and find the latest information about other applications.

Three phase capability

Three units can be configured for three-phase output. Up to 6 sets of three units can be parallel connected.

PowerControl – maximum use of limited AC power

The inverter/charger can supply a huge charging current. This implies heavy loading of the AC mains or generator. Therefore a maximum current can be set. The inverter/charger then takes other power users into account, and only uses "surplus" current for charging purposes.

PowerAssist – Extended use of generator or shore current: the inverter/charger "co-supply" feature

This feature takes the principle of PowerControl to a further dimension allowing the inverter/charger to supplement the capacity of the alternative source. Where peak power is often required only for a limited period, the inverter/charger will make sure that insufficient AC mains or generator power is immediately compensated for by power from the battery. When the load reduces, the spare power is used to recharge the battery.

Programmable relay

The inverter/charger is equipped with a programmable relay. The relay can be programmed for different applications, for example as a starter relay for a generator.

External current transformer (optional)

When used in a grid-parallel topology the internal current transformer cannot measure the current to or from the mains. In this case an external current transformer is needed to implement PowerControl and PowerAssist. See appendix.

Programmable analogue/digital input/output ports (Aux in 1 and Aux in 2, see appendix)

The inverter/charger is equipped with 2 analogue/digital input/output ports.

These ports can be used for several purposes. One application is communication with the BMS of a lithium-ion battery.

2.2. On-grid and off-grid systems combined with PV

External current transformer (optional)

When used in a grid-parallel topology the internal current transformer cannot measure the current to or from the mains. In this case an external current transformer is needed to implement PowerControl and PowerAssist. See appendix.

Frequency shift

When solar inverters are connected to the output of the inverter/charger, excess solar energy is used to recharge the batteries. Once the absorption voltage is reached, charge current will reduce and excess energy will be fed back into the mains. If mains is not available, the inverter/charger will slightly increase the AC frequency to reduce the output of the solar inverter.

Built-in Battery Monitor

The ideal solution is when the inverter/charger is part of a hybrid system (diesel generator, inverter/chargers, storage battery, and alternative energy). The built-in battery monitor can be set to start and stop the generator:

- Start at a preset % discharge level, and/or

- start (with a preset delay) at a preset battery voltage, and/or
- start (with a preset delay) at a preset load level.
- Stop at a preset battery voltage, or
- stop (with a preset delay) after the bulk charge phase has been completed, and/or
- stop (with a preset delay) at a preset load level.

Autonomous operation when the grid fails

Houses or buildings with solar panels or a combined micro-scale heating and power plant or other sustainable energy sources have a potential autonomous energy supply which can be used for powering essential equipment (central heating pumps, refrigerators, deep freeze units, Internet connections, etc.) during a power failure. A problem is, however, that grid-connected sustainable energy sources drop out as soon as the grid fails. With an inverter/charger and batteries, this problem can be solved: **the inverter/charger can replace the grid during a power failure**. When sustainable energy sources produce more power than needed, the inverter/charger will use the surplus to charge the batteries; in the event of a shortfall, the inverter/charger will supply additional power from the battery.

Programmable

All settings can be changed with a PC and free-of-charge software, downloadable from our website www.victronenergy.com

2.3. Battery charger

2.3.1. Lead-acid batteries

Adaptive 4-stage charge algorithm: bulk – absorption – float – storage

The microprocessor-driven adaptive battery management system can be adjusted for various types of batteries. The adaptive function automatically adapts the charging process to battery use.

The right amount of charge: variable absorption time

In the event of slight battery discharge, absorption is kept short to prevent overcharging and excessive gas formation. After deep discharging, the absorption time is automatically extended in order to fully charge the battery.

Preventing damage due to excessive gassing: the BatterySafe mode

If, in order to quickly charge a battery, a high charge current in combination with a high absorption voltage has been chosen, damage due to excessive gassing will be prevented by automatically limiting the rate of voltage increase once the gassing voltage has been reached.

Less maintenance and aging when the battery is not in use: the Storage mode

The Storage mode kicks in whenever the battery has not been subjected to discharge during 24 hours. In the Storage mode float voltage is reduced to 2.2V/cell (13.2V for 12V battery) to minimise gassing and corrosion of the positive plates. Once a week the voltage is raised back to the absorption level to 'equalize' the battery. This feature prevents stratification of the electrolyte and sulphation, a major cause of early battery failure.

Battery voltage sense: the correct charge voltage

Voltage loss due to cable resistance can be compensated by using the voltage sense facility to measure voltage directly on the DC bus or on the battery terminals.

Battery voltage and temperature compensation

The temperature sensor serves to reduce charging voltage when battery temperature rises. This is particularly important for maintenance-free batteries, which could otherwise dry out by overcharging.



The temperature sensor is not supplied with 48V models.
It can be ordered separately. Order number: ASS000001000

2.3.2. Second charge output for starter battery

The 12V and 24V MultiPlus is equipped with a second charge output intended for maintenance charging of a starter battery. It uses a simple circuit with a current limiter and diode, allowing a continuous trickle charge (4A) from the main (domestic) battery to the starter battery. Due to the diode's 0.3 - 0.6 V drop, charging only occurs when the main battery is being actively charged or when the starter battery's voltage is much lower.



Note that a shared negative with the main battery is required, and if a shunt is installed, the starter battery negative must be connected to the system (load) side of the shunt.

2.3.3. Victron Lithium Battery Smart

If Victron Lithium Smart batteries are used, use the VE.Bus BMS V2 or the Lynx Smart BMS.

2.3.4. Other lithium batteries

If other lithium batteries are used, follow this link for a list of compatible battery types and how to install and configure them: https://www.victronenergy.com/live/battery_compatibility:start.

2.3.5. More on batteries and battery charging

Our book "Energy Unlimited" offers further information on batteries and battery charging and is available free of charge on our website. It can be downloaded from: <https://www.victronenergy.com/upload/documents/Book-Energy-Unlimited-EN.pdf>, or a hard copy can be ordered from: <https://www.victronenergy.com/orderbook>

For more information on adaptive charging, please refer to the technical paper: [Adaptive charging, how it works](#).

2.4. ESS – Energy Storage Systems: feeding energy back into the grid*

When the inverter/charger is used in a configuration in which it will feed back energy into the grid it is required to enable grid code compliance by selecting the appropriate grid code country setting with the VEConfigure tool.

Once set, a password will be required to disable grid code compliance or change grid code related parameters.

Depending on the grid code there are several reactive Power control modes:

- Fixed $\cos \varphi$
- $\cos \varphi$ as function of P
- Fixed Q
- Q as function of input voltage

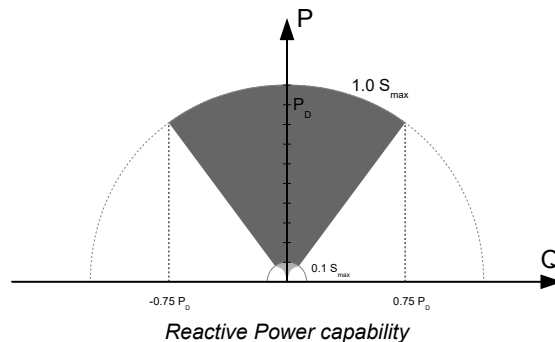

If the local grid code is not supported by the inverter/charger an external certified interface device should be used to connect the inverter/charger to the grid.

The inverter/charger can also be used as a bidirectional inverter operating parallel to the grid, integrated into a customer-designed system (PLC or other) that takes care of the control loop and grid measurement.

*This functionality is neither UL1741 certified nor CSA 22.2 No.107.1.

3. Operation

3.1. On/Off/Charger Only Switch

When switched to 'on', the inverter/charger is fully functional. The inverter will come into operation, and the LED 'inverter on' will light up.

An AC voltage connected to the 'AC in' terminal will be switched through to the 'AC out' terminal, if within specifications. The inverter will switch off, the 'mains on' LED will light up, and the charger commences charging. The 'bulk', 'absorption' or 'float' LEDs will light up, depending on the charger mode.

If the voltage at the 'AC-in' terminal is rejected, the inverter will switch on.

When the switch is switched to 'charger only', only the battery charger of the inverter/charger will operate (if mains voltage is present). The input voltage is also switched through to the 'AC out' terminal in this mode.

NOTE: When only the charger function is required, ensure that the switch is switched to 'charger only'. This prevents the inverter from being switched on if the mains voltage is lost, thus preventing your batteries from running flat.

3.2. Remote control

The inverter/charger can be remotely turned on or off via a switch connected to the remote on/off terminals, or it can be turned on, off, or set to charger-only mode via a [Digital Multi Control](#) panel or a virtual switch (for example, through Remote Console or VRM).

The Digital Multi Control panel has a simple rotary knob with which the maximum current of the L1 AC input can be set. This does not affect the L2 AC input: see [PowerControl section in the "other features" chapter](#).

3.3. Equalisation and forced absorption

3.3.1. Equalisation

Traction batteries require regular additional charging. In the equalisation mode, the inverter/charger will charge with increased voltage for one hour (1V above the absorption voltage for a 12V battery, 2V for a 24V battery and 4V for a 48V battery). The charging current is then limited to 1/4 of the set value.

When equalisation mode is activated, the 'bulk' and 'absorption' LEDs flash intermittently.



Equalisation mode supplies a higher charging voltage than most DC-consuming devices can cope with. These devices must be disconnected before additional charging takes place.

3.3.2. Forced absorption

Under certain circumstances, it can be desirable to charge the battery for a fixed time at the absorption voltage level. In Forced Absorption mode, the MultiPlus-II will charge at the normal absorption voltage level during the set maximum absorption time.

When Forced Absorption mode is active, the 'absorption' LED is illuminated.

3.3.3. Activating equalisation or forced absorption

The inverter/charger can be put into both these states from the remote panel as well as with the front panel switch, provided that all switches (front, remote, and panel) are set to 'on' and no switches are set to 'charger only'.

The procedure below should be followed to put the inverter/charger in this state.

If the switch is not in the required position after following this procedure, it can be switched over quickly once. This will not change the charging state.





Switching from 'on' to 'charger only' and back, as described below, must be done quickly. The switch must be toggled such that the intermediate position is 'skipped', as it were. If the switch remains in the 'off' position even for a short time, the device may be turned off. In that case, the procedure must be restarted at step 1. A certain degree of familiarisation is required when using the front switch on the Compact in particular. When using the remote panel, this is less critical.

Procedure:

1. Check whether all switches (i.e. front switch, remote switch or remote panel switch if present) are in the 'on' position.

2. Activating equalisation or forced absorption is only meaningful if the normal charging cycle is completed (charger is in 'Float').
3. To activate:
 - a. Switch rapidly from 'on' to 'charger only' and leave the switch in this position for ½ to 2 seconds.
 - b. Switch rapidly back from 'charger only' to 'on' and leave the switch in this position for ½ to 2 seconds.
 - c. Switch once more rapidly from 'on' to 'charger only' and leave the switch in this position.
4. On the inverter/charger (and, if connected, on the MultiControl panel), the three LEDs 'Bulk', 'Absorption' and 'Float' will now flash 5 times.
5. Subsequently, the LEDs 'Bulk', 'Absorption' and 'Float' will each light for 2 seconds.
 - a. If the switch is set to 'on' while the 'Bulk' LED lights, the charger will switch to equalisation.
 - b. If the switch is set to 'on' while the 'Absorption' LED lights, the charger will switch to forced absorption.
 - c. If the switch is set to 'on' after the three LED sequences have finished, the charger will switch to 'Float'.
 - d. If the switch has not been moved, the MultiPlus-II will remain in 'charger only' mode and switch to 'Float'.

3.4. LED Indications

-  LEDs off
-  LEDs blinking
-  LEDs illuminated

<div style="display: flex; justify-content: space-between;"> <div style="width: 45%;"> <p>charger</p> <ul style="list-style-type: none"> <input type="radio"/> mains on <input type="radio"/> bulk <input type="radio"/> absorption <input type="radio"/> float </div> <div style="width: 45%;"> <p>inverter</p> <ul style="list-style-type: none"> <input checked="" type="radio"/> inverter on <input type="radio"/> overload <input type="radio"/> low battery <input type="radio"/> temperature </div> </div>	<p>Inverting</p> <p>The inverter is on. Inverter power is supplied to the load. The "inverter" LED is on.</p>
<div style="display: flex; justify-content: space-between;"> <div style="width: 45%;"> <p>charger</p> <ul style="list-style-type: none"> <input type="radio"/> mains on <input type="radio"/> bulk <input type="radio"/> absorption <input type="radio"/> float </div> <div style="width: 45%;"> <p>inverter</p> <ul style="list-style-type: none"> <input checked="" type="radio"/> inverter on <input type="radio"/> overload <input type="radio"/> low battery <input type="radio"/> temperature </div> </div>	<p>Overload pre-alarm</p> <p>The nominal output of the inverter is exceeded. The "overload" LED is blinking</p>
<div style="display: flex; justify-content: space-between;"> <div style="width: 45%;"> <p>charger</p> <ul style="list-style-type: none"> <input type="radio"/> mains on <input type="radio"/> bulk <input type="radio"/> absorption <input type="radio"/> float </div> <div style="width: 45%;"> <p>inverter</p> <ul style="list-style-type: none"> <input checked="" type="radio"/> inverter on <input type="radio"/> overload <input type="radio"/> low battery <input type="radio"/> temperature </div> </div>	<p>Overload alarm</p> <p>The inverter is switched off due to overload or short circuit. The "overload" LED is on.</p>

charger

- mains on
- bulk
- absorption
- float

inverter

- inverter on
- overload
- low battery
- temperature

Low battery pre-alarm

The battery voltage is getting low. The battery is almost fully exhausted. The "low battery" LED is blinking.

charger

- mains on
- bulk
- absorption
- float

inverter

- inverter on
- overload
- low battery
- temperature

Low battery alarm

The inverter has switched off due to low battery voltage. The "low battery" LED is blinking.

charger

- mains on
- bulk
- absorption
- float

inverter

- inverter on
- overload
- low battery
- temperature

Temperature pre-alarm

The internal temperature is reaching a critical level. The "temperature" LED is blinking.

charger

- mains on
- bulk
- absorption
- float

inverter

- inverter on
- overload
- low battery
- temperature

Temperature alarm

The inverter has switched off due to its internal temperature being too high. The "temperature" LED is on.

charger

- mains on
- bulk
- absorption
- float

inverter

- inverter on
- overload
- low battery
- temperature

Overload pre-alarm and low battery pre-alarm

The battery is nearly exhausted and the nominal output of the inverter is exceeded. The "overload" and "low battery" LEDs are both blinking alternately,

charger

- mains on
- bulk
- absorption
- float

inverter

- inverter on
- overload
- low battery
- temperature

Ripple pre-alarm

The ripple voltage on the battery terminals is too high. The "overload" and "low battery" LEDs are both blinking simultaneously.

<p>charger</p> <ul style="list-style-type: none"> <input type="radio"/> mains on <input type="radio"/> bulk <input type="radio"/> absorption <input type="radio"/> float <p>inverter</p> <ul style="list-style-type: none"> <input checked="" type="radio"/> inverter on <input type="radio"/> overload <input type="radio"/> low battery <input type="radio"/> temperature 	<p>Ripple alarm</p> <p>The inverter has switched off due to excess ripple voltage on the battery terminals. The "overload" and "low battery" LEDs are both on.</p>
<p>charger</p> <ul style="list-style-type: none"> <input checked="" type="radio"/> mains on <input checked="" type="radio"/> bulk <input type="radio"/> absorption <input type="radio"/> float <p>inverter</p> <ul style="list-style-type: none"> <input type="radio"/> inverter on <input type="radio"/> overload <input type="radio"/> low battery <input type="radio"/> temperature 	<p>Bulk charging</p> <p>The AC input voltage is switched through and the charger operates in bulk mode. The "bulk" LED is on.</p>
<p>charger</p> <ul style="list-style-type: none"> <input checked="" type="radio"/> mains on <input checked="" type="radio"/> bulk <input checked="" type="radio"/> absorption <input type="radio"/> float <p>inverter</p> <ul style="list-style-type: none"> <input type="radio"/> inverter on <input type="radio"/> overload <input type="radio"/> low battery <input type="radio"/> temperature 	<p>BatterySafe</p> <p>The mains voltage is switched through and the charger is on. However, the set absorption voltage has not yet been reached. The "bulk" and "absorption" LEDs are both on.</p>
<p>charger</p> <ul style="list-style-type: none"> <input checked="" type="radio"/> mains on <input type="radio"/> bulk <input checked="" type="radio"/> absorption <input type="radio"/> float <p>inverter</p> <ul style="list-style-type: none"> <input type="radio"/> inverter on <input type="radio"/> overload <input type="radio"/> low battery <input type="radio"/> temperature 	<p>Absorption charging</p> <p>The mains voltage is switched through and the charger operates in absorption mode. The "absorption" LED is on.</p>
<p>charger</p> <ul style="list-style-type: none"> <input checked="" type="radio"/> mains on <input type="radio"/> bulk <input type="radio"/> absorption <input checked="" type="radio"/> float <p>inverter</p> <ul style="list-style-type: none"> <input type="radio"/> inverter on <input type="radio"/> overload <input type="radio"/> low battery <input type="radio"/> temperature 	<p>Float charging</p> <p>The mains voltage is switched through and the charger operates in float mode. The "float" LED is on.</p>
<p>charger</p> <ul style="list-style-type: none"> <input checked="" type="radio"/> mains on <input checked="" type="radio"/> bulk <input checked="" type="radio"/> absorption <input type="radio"/> float <p>inverter</p> <ul style="list-style-type: none"> <input type="radio"/> inverter on <input type="radio"/> overload <input type="radio"/> low battery <input type="radio"/> temperature 	<p>Equalize charging</p> <p>The mains voltage is switched through and the charger operates in equalize mode. The "bulk" and "absorption" LED are both blinking.</p>

<p>charger</p> <ul style="list-style-type: none"> <input checked="" type="radio"/> mains on <input type="radio"/> bulk <input type="radio"/> absorption <input type="radio"/> float 	<p>inverter</p> <ul style="list-style-type: none"> <input type="radio"/> inverter on <input type="radio"/> overload <input type="radio"/> low battery <input type="radio"/> temperature 	<p>PowerControl</p> <p>The AC input is switched through. The AC output current is equal to the preset maximum input current. The charge current is reduced to 0A. The "mains on" LED is blinking.</p>
--	--	--

<p>charger</p> <ul style="list-style-type: none"> <input checked="" type="radio"/> mains on <input type="radio"/> bulk <input type="radio"/> absorption <input type="radio"/> float 	<p>inverter</p> <ul style="list-style-type: none"> <input checked="" type="radio"/> inverter on <input type="radio"/> overload <input type="radio"/> low battery <input type="radio"/> temperature 	<p>PowerAssist</p> <p>The AC input is switched through, but the load requires more current than the preset maximum input current. The inverter is switched on to supply the required additional current. The "mains on" LED is on and the "inverter" LED is blinking.</p>
--	---	--

For more error codes, see the [Error Indications \[21\]](#) chapter.

For the latest and most up-to-date information about the blink codes, please refer to the Victron Toolkit app.

Scan the QR code or click on the link to go to the Victron Support and Downloads/Software page: <https://www.victronenergy.com/support-and-downloads/software#victron-toolkit-app>



3.5. Shut down procedure

To switch the inverter/charger off, use the on/off/charger-only only switch located on the bottom left-hand underside of the case. The middle position of the switch is the OFF position.

To completely de-power the inverter/charger, disconnect the DC fuse or turn off the isolation switch, DC contactor or DC circuit breaker, located between the battery and the DC terminals of the unit. Note that dangerous residual voltages may still exist inside the product and at its terminals after shutdown. Never open the product casing, or touch bare terminals.

3.6. Maintenance

The inverter/charger does not require specific maintenance. It will suffice to check all connections once a year. Avoid moisture and oil/soot/vapours, and keep the device clean.

4. Installation



This product may only be installed by a qualified electrical engineer.

4.1. Location

The product must be installed in a dry and well-ventilated area, as close as possible to the batteries.

The product must be installed in a manner that ensures it is not expected to come into contact with persons under normal conditions.

The inverter/charger is suitable for wall mounting. A solid surface, suitable for the weight and dimensions of the product must be available (e.g., concrete, or masonry). For mounting purposes, a hook and two holes are provided at the back of the casing (see appendix G).



The interior of the product must remain accessible after installation.

Try and keep the distance between the product and the battery to a minimum in order to minimize cable losses.



For safety reasons, this product should be installed in a cool environment. Do not store or place any flammable materials (such as chemicals, curtains, textiles, synthetic items, or other combustibles) in the immediate vicinity of the installation.



Every system installation must include a way to disconnect the AC and DC circuits. Circuit breakers used for overcurrent protection can also serve as disconnects. When fuses are used, separate disconnect switches are required between the source and the fuses.



WARNING - BATTERIES CAN PRESENT A RISK OF ELECTRIC SHOCK, BURNS FROM HIGH SHORT-CIRCUIT CURRENTS, FIRE, OR EXPLOSION FROM VENTED GASSES.

- Replace batteries with the same number and type.
- Refer to you local codes for proper battery disposal requirements.



WARNING – RISK OF EXPLOSIVE GASES. WORKING IN THE VICINITY OF A LEAD-ACID BATTERY IS HAZARDOUS. LEAD-ACID BATTERIES GENERATE EXPLOSIVE GASES DURING NORMAL OPERATION.

Please observe the following precautions when working in the vicinity of a lead-acid battery.

PERSONAL SAFETY PRECAUTIONS:

- Never work alone near a lead-acid battery. Ensure someone is close-by to assist you in case of an emergency.
- Ensure first aid and eye wash equipment is readily available before working on or near the battery.
- Wear safety goggles or a face shield and protective clothing. Avoid touching your eyes while working near a battery.
- If battery acid contacts skin or clothing, wash immediately with soap and water. If acid enters your eye, immediately flush the eye with cold running water for at least 10 minutes and seek medical attention right away.
- NEVER smoke or allow sparks or open flames within the vicinity of a battery or engine.
- Use insulated tools when working on the battery. Be extremely careful not to drop metal tools or objects onto the battery. A dropped metal tool can create sparks or cause a short circuit, which may result in an explosion or fire.
- Remove metal jewelry and watches when working with a lead-acid battery. A lead-acid battery can produce a short-circuit current high enough to melt or weld a ring or similar metal object to metal, causing severe burns.
- NEVER charge a frozen battery.
- If removing the battery from a vehicle or vessel, always remove grounded terminal from the battery first. Switch off all circuits before connecting or disconnecting the battery terminals to prevent arcing.
- Ensure the battery is installed in a well ventilated space.
- Keep the battery terminals clean and free of corrosion. Prevent corrosion material from coming in contact with eyes.
- Always follow the battery manufacturer's specific precautions and instructions. This includes whether or not to remove the cell caps while charging and observe the recommended charging rates.



MARINE UNIT LOCATION

- Locate marine unit away from battery in a separate, well ventilated compartment
- Never place marine unit directly above the battery; corrosive battery gases will damage it.
- Never allow battery acid to drip onto the marine unit when reading gravity or filling the battery.
- Do not operate the marine unit in a closed-in area or restrict ventilation in any way.



DC CONNECTION PRECAUTIONS

Connect and disconnect DC output connections only after setting any marine unit switches to off position. Disconnect AC cords from electric outlets or open AC disconnect switches.



EXTERNAL CONNECTIONS SHALL COMPLY WITH THE UNITED STATES COAST GUARD ELECTRICAL REGULATIONS (33CFR183, SUB PART I).



GROUNDING INSTRUCTIONS – A marine unit should be connected to a grounded, metal, permanent wiring system; or an equipment-grounding conductor should be run with circuit conductors and connected to equipment-grounding terminal or lead on unit. Connections to the unit should comply with all local codes and ordinances.



This product is not suitable for direct connection to a vehicle's electrical system. It should be connected to a DC system that includes its own dedicated service or house battery with appropriate fusing, and DC wiring gauge. For recommendations on battery capacity, fuse rating, and cable gauge, refer to Chapter [Connection of battery cables \[13\]](#) in this manual."

4.2. Vibration management



CAUTION

When integrating inverter/chargers with generators in a single enclosure (hybrid generators), using shock mounts is mandatory. They mitigate damage risk to the inverter/charger by absorbing the generator's operational energy, thus extending component lifespan.

Key criteria for selecting shock mounts include:

- Selection is based on the specific generator vibration frequency ranges to be isolated.
- The shock mounts must bear the equipment's weight without impairing functionality.

4.3. Connection of battery cables

To fully utilize the product's capacity, ensure the use of batteries with adequate capacity, an appropriate DC fuse, and battery cables of sufficient cross-section. DC cables should be copper, with a 90°C (194°F) rating. Refer to the table below for sizing recommendations.

In Canada, battery installation should be in accordance with the storage battery rules of the Canadian Electrical Code, Part I.

A battery disconnection mechanism must be included as part of the installation. It should be capable of being connected to the DC terminals and must be rated for at least the DC fuse current requirements specified in the table below:

Model	Battery capacity	DC fuse	Cross-section per positive and negative terminal connection for cables between 0 and 5m [*] , ^{**} , ^{***}	Cross-section per positive and negative terminal connection for cables between 5 and 10m [*] , ^{**} , ^{***}
12/3000/120	400 - 1200Ah	400A	2x AWG 1/0	2x AWG 2/0
12/4k/160	400 - 1200Ah	600A	2x AWG 2/0	2x AWG 4/0
24/3000/70	200 - 700Ah	300A	AWG 1/0	2x AWG 1/0
48/3000/35	100 - 400Ah	125A	AWG 1	AWG 2/0
24/5000/120	400 - 1200Ah	400A	2x AWG 1/0	2x AWG 2/0
48/5000/70	200 - 800Ah	200A	AWG 2/0	AWG 4/0

* Follow local installation rules.

** Do not locate battery cables in a closed conduit

Connection procedure



Use a torque wrench with an insulated box spanner in order to avoid shorting the battery.

Recommended torque: 12 Nm (M8 nut)

Avoid shorting the battery cables.

Proceed as follows to connect the battery cables:

- Undo the two screws at the bottom of the enclosure and remove the service panel
- Connect the battery cables: see [A: Connection overview \[31\]](#).
- Tighten the nuts well for minimal contact resistance.
- The connector goes on first, followed by the flat washer, lock washer, and nut. Tighten the nuts well for minimal contact resistance.

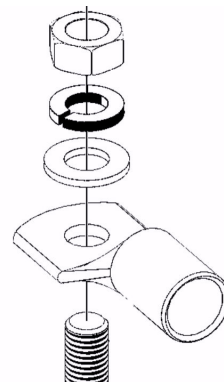

Internal resistance is an important factor when working with low-capacity batteries. Please consult your supplier or the relevant sections of our [Energy Unlimited](#) or [Wiring Unlimited](#) books. Both can be downloaded from our website.

4.4. Connection of the AC cabling



This is a safety class I product (supplied with a ground terminal for safety purposes). **Its AC input and/or output terminals and/or grounding point on the outside of the product must be provided with an uninterruptible grounding point for safety purposes.**

This product is provided with a ground relay (relay H, see appendix B) **that automatically connects the Neutral output to the chassis if no external AC supply is available.** If an external AC supply is provided, the ground relay H will open before the input safety relay closes. This ensures the correct operation of an earth leakage circuit breaker connected to the output.

- In a fixed installation, an uninterruptible grounding can be secured by means of the grounding wire of the AC input. Otherwise, the casing must be grounded.
- In a mobile installation (for example, with a shore current plug), interrupting the shore connection will simultaneously disconnect the grounding connection. In that case, the casing must be connected to the chassis (of the vehicle) or to the hull or grounding plate (of the boat).

The inverter incorporates a mains frequency isolating transformer. This precludes the possibility of DC current at any AC port. Therefore, type A RCDs can be used.

In case of a boat, direct connection to the shore ground is not recommended because of potential galvanic corrosion. The solution to this is using an isolation transformer.



This unit or system is provided with fixed trip limits and shall not be aggregated above 30kW on a single point of common connection.

The AC terminal blocks can be found on the printed circuit board, see Appendix A.

Do not invert neutral and phase when connecting the AC.

The AC connections need to be made with three-wire 90°C (194°F) copper cable.

MultiPlus-II 120V - 3k and 4k models	AC-in	AC-out-1	AC-Out-2
Rated current	50 A	50 A	32 A
Recommend fuse or circuit breaker	50 A	50 A	32 A
Minimum wire gauge	AWG 6	AWG 6	AWG 10
Ferrule pin and stripping length	0.7 inch (18 mm)	0.7 inch (18 mm)	0.7 inch (18 mm)
Note that AC-in and AC-out-1 have an M40 cable gland, and AC-out-2 has an M32 cable gland.			

MultiPlus-II 120V - 5k models	AC-in	AC-out-1	AC-Out-2
Rated current	95 A	115 A	48 A
Recommend fuse or circuit breaker	95 A	115 A	48 A
Minimum wire gauge	AWG 4	AWG 2	AWG 4
Ferrule pin and stripping length	0.7 inch (18 mm)	0.7 inch (18 mm)	0.7 inch (18 mm)

- **AC-in** (Maximum Torque: 2 Nm)

The AC input cable can be connected to the terminal block 'AC-in'.

From left to right: "N" (neutral), "PE" (earth) and "L" (phase)

The AC input must be protected by a fuse or magnetic circuit breaker rated at 50A (for 3kVA model) and 95A (for 5kVA model) or less, and the cable cross-section must be sized accordingly. If the input AC supply is rated at a lower value, the fuse or magnetic circuit breaker should be downsized accordingly. If the input AC supply is rated at a lower value, the fuse or magnetic circuit breaker should be downsized accordingly.

- **AC-out-1** (Maximum Torque: 2 Nm)

The AC output cable can be connected directly to the terminal block 'AC-out'.

From left to right: "N" (neutral), "PE" (earth) and "L" (phase)

With its PowerAssist feature the inverter/charger can add up to 3 kVA (that is 3000 / 120 = 25 A) to the output during periods of peak power requirement. Together with a maximum input current of 50 A, the output can supply up to 50 + 25 = 75 A. On the 48/3000/35-50 unit, AC-out-1 is limited to 50A. A UL 943 compliant residual current circuit breaker (RCCD) and fuse or circuit breaker rated to support the expected load must be included in series with the output, and the cable cross-section must be sized accordingly.

And for the 5kVA model the inverter/charger can add up to 5 kVA (that is $5000 / 120 = 42$ A) to the output during periods of peak power requirement. Together with a maximum input current of 95 A, the output can supply up to $95 + 42 = 137$ A. A UL 943 compliant residual current circuit breaker (RCCD) and fuse or circuit breaker rated to support the expected load must be included in series with the output, and the cable cross-section must be sized accordingly.

- **AC-out-2** (Maximum Torque: 2 Nm)

A second output is available that disconnects its load in the event of battery operation. On these terminals, equipment is connected that may only operate if AC voltage is available on AC-in-1, e.g. an electric boiler or an air conditioner. The load on AC-out-2 is disconnected immediately when the inverter/charger switches to battery operation. After AC power becomes available on AC-in-1, the load on AC-out-2 will be reconnected with a delay of approximately 2 minutes. This to allow a genset to stabilise.

A UL 943 compliant residual current circuit breaker (RCCD) and fuse or circuit breaker rated at max. 32A must be connected in series with AC-out-2.

4.5. Optional Connections

A number of optional connections are possible:

4.5.1. Remote Control

The product can be remotely controlled in two ways.

- With an external switch connected to the "Remote on/off connector" terminal (see Appendix A). Operates only if the switch on the inverter/charger is set to "on".
- With a [Digital Multi Control](#) panel connected to one of the two VE.Bus RJ45 sockets (see Appendix A). Operates only if the switch on the inverter/charger is set to "on".

See Appendix A for the location of the connector.

4.5.2. Programmable relay

The product is equipped with a programmable relay.

The relay can be programmed for all kinds of other applications however, for example as a starter relay for a generator.

See Appendix A for the location of the connector.

4.5.3. Programmable I/O ports

The product is equipped with 2 analogue/digital input/output ports.

These ports can be used for several purposes. One application is communication with the BMS of a lithium-ion battery.

See Appendix A for the location of the connector.

4.5.4. Starter battery

The 12 and 24V models have a connection for charging a starter battery. Output current is limited to 4A.

See Appendix A for the location of the connector.

4.5.5. Voltage sense

For compensating possible cable losses during charging, two sense wires can be connected with which the voltage directly on the battery or on the positive and negative distribution points can be measured. Use wire with a cross-section of 0.75mm^2 (AWG 18).

During battery charging, the inverter/charger will compensate the voltage drop over the DC cables up to a maximum of 1 Volt (i.e. 1V over the positive connection and 1V over the negative connection). If the voltage drop threatens to become larger than 1V, the charging current is limited in such a way that the voltage drop remains limited to 1V.

See Appendix A for the location of the connector.

4.5.6. Temperature sensor

For temperature-compensated charging, a temperature sensor can be connected. The sensor is isolated and must be fitted to the negative terminal of the battery.



The temperature sensor is not supplied with 48V models.

It can be ordered separately. Order number: ASS000001000

See Appendix A for the location of the connector.

4.5.7. Parallel connection

Up to six identical units, can be connected in parallel. When connecting inverter/charger units in parallel, the following requirements must be met:

- All units must be connected to the same battery.
- A maximum of six units can be connected in parallel.
- Only identical devices may be connected in parallel.
- The DC connection cables to the devices must be of equal length and cross-section.
- If a positive and a negative DC distribution point is used, the cross-section of the connection between the batteries and the DC distribution point must at least equal the sum of the required cross-sections of the connections between the distribution point and the inverter/charger units.
- Place the inverter/charger units close to each other, but allow at least 10cm for ventilation purposes under, above and beside the units.
- UTP cables must be connected directly from one unit to another (and to the remote panel). Connection or splitter boxes are not permitted.
- Always interconnect the negative battery cables before placing the UTP cables.
- Only one remote control means (panel or switch) can be connected to the system.

4.5.8. Three-phase connection

The inverter/charger can also be used in a 3-phase wye (Y) configuration. To this end, the devices are connected by means of standard RJ45 UTP cables (the same as for parallel operation). The system of inverter/chargers (and the optional Digital Multi Control panel) will require subsequent configuration (see the [Configuration \[17\]](#) chapter).

For prerequisites, see the [Parallel connection \[16\]](#) chapter.



The inverter/charger is unsuitable for a three-phase delta (Δ) configuration.
Strings of paralleled units can be connected in three phases.

5. Configuration

This section is intended mainly for stand-alone applications.



Settings may only be changed by a qualified electrical engineer.
Read the instructions thoroughly before implementing changes.
During the configuration of the charger, the AC input must be removed.

5.1. Standard settings: ready for use

On delivery, the inverter/charger is set to standard factory values. These settings are generally suitable for single-unit operation.



It is a possibility that the standard charging voltage does not suit your batteries. Consult the manufacturer's documentation or your battery supplier.

Setting	Default value
Inverter frequency	60Hz (can be adjusted to 50Hz for the 50/60Hz models)
Input frequency range	55 - 65Hz (45 - 65Hz for the 50/60Hz models)
Input voltage range	90 - 140VAC
Inverter voltage	120VAC
Stand-alone, parallel or 3-phase	stand-alone
AES (Automatic Economy Switch)	off
Ground relay	on
Charger on/ off	on
Battery charge curve	four-stage adaptive with BatterySafe mode
Charging current	100% of the maximum charging current
Battery type	Victron Gel Deep Discharge (also suitable for Victron AGM Deep Discharge)
Automatic equalisation charging	off
Absorption voltage	14.4V / 28.8V / 57.6V
Absorption time	up to 8 hours (depending on bulk time)
Float voltage	13.8V / 27.6V / 55.2V
Storage voltage	13.2V / 26.4V / 52.8V (not adjustable)
Repeated absorption time	1 hour
Absorption repeat interval	7 days
Bulk protection	on
AC input current limit	50A for 3kVA and 95A for 5kVA (= adjustable current limit for PowerControl and PowerAssist functions)
UPS feature	on
Dynamic current limiter	off
WeakAC	off
BoostFactor	2
Programmable relay	alarm function
PowerAssist	on

5.2. Explanation of settings

Settings that are not self-explanatory are described briefly below. For further information, please refer to the help files in the software configuration programs. See the [Configuring \[20\]](#) chapter.

Inverter frequency

Output frequency if no AC is present at the input.

This setting is not adjustable; it is permanently set to 60Hz.

Input frequency range

Input frequency range accepted by the MultiPlus-II. The MultiPlus-II synchronises within this range with the AC input frequency. The output frequency is then equal to the input frequency.

Adjustability: 60 or 55 – 65 Hz.

Input voltage range

Voltage range accepted by the MultiPlus-II. The MultiPlus-II synchronises within this range with the AC input. The output voltage is then equal to the input voltage.

Adjustability: Lower limit: 90 – 120V
Upper limit: 120 – 140V



The standard lower limit setting of 90V is intended for connection to a weak mains supply, or to a generator with unstable AC output. This setting may result in a system shut down when connected to a 'brushless, self-excited, externally voltage regulated, synchronous AC generator' (synchronous AVR generator). Most generators rated at 10kVA or more are synchronous AVR generators. The shutdown is initiated when the generator is stopped and revs down while the AVR simultaneously 'tries' to keep the output voltage of the generator at 120V.

The solution is to increase the lower limit setting to 110VAC (the output of AVR generators is generally very stable), or to disconnect the inverter/charger from the generator when a generator stop signal is given (with the help of an AC contactor installed in series with the generator).

Inverter voltage

Output voltage of the MultiPlus-II in battery operation.

Adjustability: 110 - 130V

Stand-alone / parallel operation / 2-phase / 3-phase setting

Using several devices, it is possible to:

- Increase the total inverter power by connecting several devices in parallel.
- Create a split-phase system with a separate autotransformer: see the Victron [Autotransformer product page](#).
- Create a 3-phase system.

The standard product settings are for standalone operation. For parallel, three-phase or split-phase operation, see the [Configuring \[20\]](#) chapter.

AES (Automatic Economy Switch)

If this setting is turned 'on', the power consumption in no-load operation and with low loads is decreased by approximately 20%, by slightly 'narrowing' the sinusoidal voltage. Applicable in stand-alone configuration only.

Search Mode

Instead of the AES mode, the **search mode** can also be chosen. If search mode is 'on', the power consumption in no-load operation is decreased by approximately 70%. In this mode the MultiPlus-II, when operating in inverter mode, is switched off in case of no load or very low load, and switches on every two seconds for a short period. If the output current exceeds a set level, the inverter will continue to operate. If not, the inverter will shut down again.

The Search Mode 'shut down' and 'remain on' load levels can be set with VEConfigure.

The standard settings are:

Shut down: 40 Watt (linear load)

Turn on: 100 Watt (linear load)

Ground relay (see appendix B)

With this relay, the neutral conductor of the AC output is grounded to the chassis when the AC input relays are open. This ensures the correct operation of earth leakage circuit breakers in the AC output.

For specific configurations, such as a split-phase system with an autotransformer, an external ground relay may be necessary. To use an external relay, first, disable the internal ground relay in the MultiPlus settings. For the location of the external ground relay contacts, see Appendix A.

Battery charge algorithm

The standard setting is 'Four-stage adaptive with BatterySafe mode'. See Section 2 for a description.

This is the recommended charge algorithm for lead acid batteries. See the help files in the software configuration programs for other settings.

Battery type

The standard setting is the most suitable for Victron Gel Deep Discharge, Gel Exide A200, and tubular plate stationary batteries (OPzS).

This setting can also be used for many other batteries: e.g. Victron AGM Deep Discharge and other AGM batteries, and many types of flat-plate flooded batteries.

With VEConfigure the charge algorithm can be adjusted to charge any battery type (Nickel Cadmium batteries, Lithium-ion batteries).

Absorption time

In case of the standard-setting 'Four-stage adaptive with BatterySafe mode' the absorption time depends on the bulk time (adaptive charge curve), so that the battery is optimally charged.

Automatic equalisation charging

This setting is intended for flooded tubular plate traction or OPzS batteries. During the absorption stage, the voltage limit increases to 2.83V/cell (34V for a 24V battery and 68V for a 48V battery) once the charge current has dropped to less than 10% of the set maximum current.

Not adjustable with DIP switches.

See 'tubular plate traction battery charge curve' in VEConfigure.

Storage voltage, Repeated Absorption Time, Absorption Repeat Interval

See [Section 2 \[3\]](#).

Bulk Protection

When this setting is 'on', the bulk charging time is limited to 10 hours. A longer charging time could indicate a system error (e.g. a battery cell short-circuit).

AC input current limit

These are the current limit settings for which PowerControl and PowerAssist come into operation:

Model	PowerAssist setting range, grid in-line topology	PowerAssist setting range, grid parallel topology with external 50 or 100A current transformer
3000VA	9.5 - 50A	9.5 - 50/100A
4k	9.5 - 50A	9.5 - 50/100A
5000VA	10.9 - 100A	10.9 - 100A

Factory setting: maximum grid in-line topology value.

UPS feature

If this setting is 'on' and AC on the input fails, the MultiPlus-II switches to inverter operation practically without interruption.

The output voltage of some small generator sets is too unstable and distorted for using this setting – the MultiPlus-II would continually switch to inverter operation. For this reason, the setting can be turned off. The MultiPlus-II will then respond less quickly to AC input voltage deviations. The switchover time to inverter operation is consequently slightly longer, but most equipment (most computers, clocks or household equipment) is not adversely impacted.

Recommendation: Turn the UPS feature off if the MultiPlus-II fails to synchronise, or continually switches back to inverter operation.

Dynamic current limiter

Intended for generators, the AC voltage being generated by means of a static inverter (so-called 'inverter' generators). In these generators, engine rpm is reduced in case of low load: this reduces noise, fuel consumption and pollution. A disadvantage is that the output voltage will drop severely or even completely fail in the event of a sudden load increase. More load can only be supplied after the engine is up to speed.

If this setting is 'on', the MultiPlus-II will start supplying extra power at a low generator output level and gradually allow the generator to supply more, until the set current limit is reached. This allows the generator engine to get up to speed.

This setting is also often used for 'classical' generators that respond slowly to sudden load variation.

Weak AC

Strong distortion of the input voltage can result in the charger hardly operating or not operating at all. If WeakAC is set, the charger will also accept a strongly distorted voltage, at the cost of greater distortion of the input current.

Recommendation: Turn WeakAC on if the charger is hardly charging or not charging at all (which is quite rare!). Also turn on the dynamic current limiter simultaneously, and reduce the maximum charging current to prevent overloading the generator if necessary.



When WeakAC is on, the maximum charge current is reduced by approximately 20%.

BoostFactor

Change this setting only after consulting with Victron Energy or with an engineer trained by Victron Energy!

Programmable relay

The relay can be programmed for all kinds of other applications, for example as a starter relay for a generator.

Auxiliary AC output (AC-out-2)

Intended for non-critical loads and directly connected to the AC input. With current measurement circuit to enable PowerAssist.

5.3. Configuring

The following hardware is required:

- A [MK3-USB](#) (VE.Bus to USB) interface.
- [RJ45 UTP cable](#)

5.3.1. VictronConnect app

The MultiPlus is configured using the VictronConnect app.

More general information about the VictronConnect app, like how to install it, how to pair it with your device, and how to update firmware, can be found by referring to the overall [VictronConnect manual](#).

5.3.2. VEConfigure

All settings can be changed with a PC and free of charge software VEConfigure, downloadable from our website www.victronenergy.com.

See the [VEConfigure manual](#) for more information.

5.3.3. VE.Bus Quick Configure Setup

VE.Bus Quick Configure Setup is a software program with which systems with a maximum of three inverters/chargers can be configured in parallel or three-phase in a simple manner.

The software can be downloaded free of charge at www.victronenergy.com.

5.3.4. VE.Bus System Configurator

For configuring advanced applications and/or systems with four or more Multis, **VE.Bus System Configurator** software must be used.

The software can be downloaded free of charge at www.victronenergy.com.

6. Error Indications

With the procedures below, most errors can be quickly identified. If an error cannot be resolved, please refer to your Victron Energy supplier.

Our recommendation is to use the Victron Toolkit app to find the description of all possible LED alarm codes. See here for download information: <https://www.victronenergy.com/support-and-downloads/software#victron-toolkit-app>.

6.1. General error indications

Problem	Cause	Solution
No output voltage on AC-out-2.	Operating in inverter mode	Connect the inverter/charger to an AC source, and after a 2-minute delay, the AC-out-2 should become live.
Unable to switch over to generator or mains operation.	Circuit breaker or fuse in the AC-in input is open as a result of overload.	Remove overload or short circuit on AC-out-1 or AC-out-2, and reset the fuse or circuit breaker.
Inverter operation not initiated when switched on	The battery voltage is excessively high or too low. No voltage on DC connection.	Ensure that the battery voltage is within the correct range.
'Low battery' LED flashes	The battery voltage is low.	Charge the battery or check the battery connections.
Low battery' LED lights.	The converter switches off because the battery voltage is too low.	Charge the battery or check the battery connections.
'Overload' LED flashes.	The converter load is higher than the nominal load.	Reduce the load.
'Overload' LED lights	The converter is switched off due to excessively high load.	Reduce the load.
'Temperature' LED flashes or lights.	The environmental temperature is high, or the load is too high.	Install the converter in cool and well-ventilated environment, or reduce the load.
'Low battery' and 'overload' LEDs flash intermittently.	Low battery voltage and excessively high load.	Charge the batteries, disconnect or reduce the load, or install higher capacity batteries. Fit shorter and/or thicker battery cables.
'Low battery' and 'overload' LEDs flash simultaneously.	Ripple voltage on the DC connection exceeds 1.5 Vrms.	Check the battery cables and battery connections. Check whether battery capacity is sufficiently high, and increase this if necessary.
'Low battery' and 'overload' LEDs light.	The inverter is switched off due to an excessively high ripple voltage on the input.	Install batteries with a larger capacity. Fit shorter and/or thicker battery cables, and reset the inverter (switch off, and then on again).
One alarm LED lights and the second flashes.	The inverter is switched off due to alarm activation by the lighted LED. The flashing LED indicates that the inverter was about to switch off due to the related alarm.	Check this table for appropriate measures in regard to this alarm state.
The charger does not operate.	The AC input voltage or frequency is not within the range set.	Ensure that the AC input is between 97 VAC and 140 VAC, and that the frequency is within the range set (default setting 45-65 Hz).
	Circuit breaker or fuse in the AC-in input is open as a result of overload.	Remove overload or short circuit on AC-out-1 or AC-out-2, and reset fuse/breaker.
	The battery fuse has blown.	Replace the battery fuse.
	The distortion or the AC input voltage is too large (generally generator supply).	Turn the "Weak AC" and "Dynamic current limiter" settings on.

Problem	Cause	Solution
The charger does not operate. 'Bulk' LED flashes and 'Mains on' LED illuminates	Charger is in 'Bulk protection' mode thus, the maximum bulk charging time of 10 hours is exceeded. Such a long charging time could indicate a system error (e.g. a battery cell short-circuit).	Check your batteries.  You can reset the error mode by switching the unit off and back on again. In the standard factory settings the 'Bulk protection' mode is enabled. The 'Bulk protection' mode can be switched off with the help of VEConfigure only.
The battery is not completely charged.	Charging current excessively high, causing premature absorption phase.	Set the charging current to a level between 0.1 and 0.2 times the battery capacity.
	Poor battery connection.	Check the battery connections.
	The absorption voltage has been set to an incorrect level (too low).	Set the absorption voltage to the correct level.
	The float voltage has been set to an incorrect level (too low).	Set the float voltage to the correct level.
	The available charging time is too short to fully charge the battery.	Select a longer charging time or higher charging current.
	The absorption time is too short. For adaptive charging this can be caused by an extremely high charging current with respect to battery capacity, so that bulk time is insufficient.	Reduce the charging current or select the 'fixed' charging characteristics.
The battery is overcharged.	The absorption voltage is set to an incorrect level (too high).	Set the absorption voltage to the correct level.
	The float voltage is set to an incorrect level (too high).	Set the float voltage to the correct level.
	Poor battery condition.	Replace the battery.
	The battery temperature is too high (due to poor ventilation, excessively high environmental temperature, or excessively high charging current).	Improve ventilation, install batteries in a cooler environment, reduce the charging current, and connect the temperature sensor.
The charging current drops to 0 as soon as the absorption phase initiates.	The battery is over-heated (>50°C)	<ul style="list-style-type: none"> • Install the battery in a cooler environment • Reduce the charging current • Check whether one of the battery cells has an internal short circuit
	Defective battery temperature sensor	Disconnect the temperature sensor. If charging functions correctly after approximately 1 minute, the temperature sensor should be replaced.

6.2. Special LED indications

For the normal LED indications, see the [LED Indications \[7\]](#) chapter.

'Mains on' flashes and there is no output voltage	The device is in 'charger only' operation and mains supply is present. The device rejects the mains supply or is still synchronising.
Bulk and absorption LEDs flash synchronously (simultaneously).	Voltage sense error. The voltage measured at the voltage sense connection deviates too much (more than 7V) from the voltage on the positive and negative connection of the device. There is probably a connection error. The device will remain in normal operation.
Absorption and float LEDs flash synchronously (simultaneously).	The battery temperature, as measured, has an extremely unlikely value. The sensor is probably defective or has been incorrectly connected. The device will remain in normal operation.



If the "inverter on" LED flashes in phase opposition, this is a VE.Bus error code (see next chapters).

6.3. VE.Bus LED indications

Equipment included in a VE.Bus system (a parallel or 3-phase arrangement) can provide so-called VE.Bus LED indications. These LED indications can be subdivided into two groups: OK codes and error codes.

6.3.1. VE.Bus OK codes

If the internal status of a device is in order but the device cannot yet be started because one or more other devices in the system indicate an error status, the devices that are in order will indicate an OK code. This facilitates error tracing in a VE.Bus system, since devices not requiring attention are easily identified as such.



OK codes will only be displayed if a device is not in inverter or charging operation!

- A flashing 'bulk' LED indicates that the device can perform inverter operation.
- A flashing 'float' LED indicates that the device can perform charging operation.



In principle, all other LEDs must be off. If this is not the case, the code is not an OK code. However, the following exceptions apply:

- The special LED indications above can occur together with the OK codes.
- The 'low battery' LED can function together with the OK code that indicates that the device can charge.

6.3.2. VE.Bus error codes

A VE.Bus system can display various error codes. These codes are displayed with the "inverter on", "bulk", "absorption" and "float" LEDs.

To interpret a VE.Bus error code correctly, the following procedure should be followed:

1. The device should be in error (no AC output).
2. Is the 'inverter on' LED flashing? If not, then there is no VE.Bus error code.
3. If one or more of the LEDs 'bulk', 'absorption' or 'float' flashes, then this flash must be in phase opposition to the 'inverter on' LED, i.e. the flashing LEDs are off if the 'inverter on' LED is on, and vice versa. If this is not the case, then there is no VE.Bus error code.
4. Check the 'bulk' LED, and determine which of the three tables below should be used.
5. Select the correct column and row (depending on the 'absorption' and 'float' LEDs), and determine the error code. 6. Determine the meaning of the code in the tables below.
6. Determine the meaning of the code in the tables below.

All of the conditions below must be met!:

1. The device is in error! (No AC output)
2. Inverter LED flashes (in opposition to any flashing of the Bulk, Absorption or Float LED)
3. At least one of the LEDs Bulk, Absorption and Float is on or flashing













Bulk LED off		Absorption LED		
		off	flashing	on
Float LED	off	0	3	6
	flashing	1	4	7
	on	2	5	8

Bulk LED flashes		Absorption LED		
		off	flashing	on
Float LED	off	9	12	15

	flashing	10	13	16
	on	11	14	17

Bulk LED on		Absorption LED		
		off	flashing	on
Float LED	off	18	21	24
	flashing	19	22	25
	on	20	23	26

Bulk, Absorption, Float LEDs	Code	Description	Cause/solution
○ ○ ☀	1	Device is switched off because one of the other phases in the system has switched off.	Check the failing phase.
○ ☀ ○	3	Not all, or more than, the expected devices were found in the system.	The system is not properly configured. Reconfigure the system. Communication cable error. Check the cables and switch all equipment off, and then on again.
○ ☀ ☀	4	No other device whatsoever detected	Check the communication cables.
○ ☀ ☀	5	Overvoltage on AC-out.	Check the AC cables.
☀ ○ ☀	10	System time synchronisation problem occurred.	Should not occur in correctly installed equipment. Check the communication cables.
☀ ☀ ☀	14	Device cannot transmit data.	Check the communication cables (there may be a short circuit)
○ ☀ ☀	17	One of the devices has assumed 'master' status because the original master failed.	Check the failing unit. Check the communication cables.
☀ ○ ○	18	Overvoltage has occurred	Check AC cables.

Bulk, Absorption, Float LEDs	Code	Description	Cause/solution
  	22	This device cannot function as 'slave'.	This device is an obsolete and unsuitable model. It should be replaced
  	24	Switch-over system protection initiated.	Should not occur in correctly installed equipment. Switch all equipment off, and then on again. If the problem recurs, check the installation. Possible solution: increase lower limit of AC input voltage to 110 VAC (factory setting is 90 VAC)
  	25	Firmware incompatibility. The firmware of one the connected devices is not sufficiently up to date to operate in conjunction with this device.	<ol style="list-style-type: none"> 1. Switch all equipment off. 2. Switch the device returning this error message on. 3. Switch on all other devices one by one until the error message reoccurs. 4. Update the firmware in the last device that was switched on.
  	26	Internal error.	Should not occur. Switch all equipment off, and then on again. Contact Victron Energy if the problem persists.

7. Technical specifications

MultiPlus-II 120V	12/3000/120-50	12/4k/160-50	24/3000/70-50	48/3000/35-50
PowerControl & PowerAssist	Yes			
Transfer switch	50A			
Maximum AC input current	50A			
INVERTER				
DC Input voltage range	9.5 - 17V	9.5 - 17V	19 - 33V	38 - 66V
Output in inverter mode	Output voltage: 120VAC \pm 2% Frequency: 60Hz \pm 0.1%			
Continuous output power at 25°C ⁽²⁾	3000VA		3000VA	3000VA
Continuous output power at 25°C	2400W	3.4kW	2400W	2400W
Continuous output power at 40°C	2200W	3.1kW	2200W	2200W
Continuous output power at 65°C	1700W	2.4kW	1700W	1700W
Time limited power 1 (cold start)		4.0kW/1h		
Time limited power 2 (cold start)		4.5kW/30min		
Peak power	5500W	6kW/2s	5500W	5500W
Maximum efficiency	93%	93%	94%	95%
Zero load power	13W	18W	13W	11W
Zero load power in AES mode	9W	11W	9W	7W
Zero load power in Search mode	3W	4W	3W	2W
CHARGER				
AC Input	Single phase: 90-140VAC 55 - 65Hz			
Charge voltage 'absorption'	14.4V	14.4V	28.8V	57.6V
Charge voltage 'float'	13.8V	13.8V	27.6V	55.2V
Storage mode	13.2V	13.2V	26.4V	52.8V
Maximum battery charge current ⁽³⁾	120A	160A	70A	35A
Battery temperature sensor	Yes			Optional. Order number: ASS000001000
GENERAL				
Auxiliary output ⁽⁴⁾	32A			
External AC current sensor (optional)	100A			
Programmable relay ⁽⁵⁾	Yes			
Protection ⁽¹⁾	a - g			
VE.Bus communication port	For parallel, split phase and three phase operation, remote monitoring and system integration			
General purpose com. port ⁽⁶⁾	Yes, 2x			
Remote on-off	Yes			

MultiPlus-II 120V	12/3000/120-50	12/4k/160-50	24/3000/70-50	48/3000/35-50
Ambient temperature range	-40 to +65°C (-40 - 150°F) fan assisted cooling			
Maximum humidity (non-condensing)	95%			
ENCLOSURE				
Material & Colour	Steel, blue RAL 5012			
Protection category	IP21			
Battery-connection	2x2 M8 bolts	2x2 M8 bolts	2 M8 bolts	2 M8 bolts
120 VAC connection	Screw terminals 13mm ² (6 AWG)			
Weight	19 kg (42 lb)	22 kg (49 lb)	19 kg (42 lb)	19 kg (42 lb)
Dimensions hwxwd	578 x 277 x 148 mm 22.7 x 10.9 x 5.8 inch	631 x 277 x 164 mm 24.8 x 10.9 x 6.5 inch	536 x 277 x 147 mm 21.1 x 10.9 x 5.8 inch	572 x 277 x 147 mm ⁽⁷⁾ 22.5 x 10.9 x 5.8 inch ⁽⁷⁾
STANDARDS				
Listing	UL 458	UL 458	UL 458	UL1741
Safety	EN-IEC 60335-1, EN-IEC 60335-2-29, CSA 22.2 107.1-16			
Emission, Immunity	EN 55014-1, EN 55014-2 EN-IEC 61000-3-2, EN-IEC 61000-3-3 IEC 61000-6-1, IEC 61000-6-2, IEC 61000-6-3			
1.	Protection key:	2.	Non-linear load, crest factor 3:1	
a.	output short circuit	3.	Up to 75°F / 25°C ambient	
b.	overload	4.	Switches off when no external AC source available	
c.	battery voltage too high	5.	Programmable relay, which can be set for general alarm, DC under voltage or genset start/stop function. AC rating: 120V / 4A, DC rating: 4A up to 35VDC and 1A up to 60VDC	
d.	battery voltage too low	6.	Use, for example, to communicate with a Lithium-Ion battery BMS	
e.	temperature too high	7.	Dimensions of the not UL1741 certified model: 536 x 277 x 147 mm / 21.1 x 10.9 x 5.8 inch	
f.	120VAC on inverter output			
g.	input voltage ripple too high			

MultiPlus-II 120V	24/5000/120-95	48/5000/70-95
PowerControl & PowerAssist	Yes	
Transfer switch	95A	
Maximum AC input current	95A	
INVERTER		
DC Input voltage range	19 - 33V	48V
Output in inverter mode	Output voltage: 120VAC ± 2% Frequency: 60Hz ± 0,1%	
Continuous output power at 25°C ⁽²⁾	5000VA	
Continuous output power at 25°C	4000VA	
Continuous output power at 40°C	3700VA	
Continuous output power at 65°C	3000VA	
Peak power	9000VA	
Maximum efficiency	95%	96%

MultiPlus-II 120V	24/5000/120-95	48/5000/70-95
Zero load power	24W	19W
Zero load power in AES mode	10W	10W
Zero load power in Search mode	3W	3W
CHARGER		
AC Input	Single phase: 90-140VAC 45-65Hz	
Charge voltage 'absorption'	28.8V	57.6V
Charge voltage 'float'	27.6V	55.2V
Storage mode	26.4V	52.8V
Maximum battery charge current ⁽³⁾	95A	70A
Battery temperature sensor	Yes	Optional. Order number: ASS000001000
GENERAL		
Auxiliary output ⁽⁴⁾	43A	48A
External AC current sensor (optional)	100A	
Programmable relay ⁽⁵⁾	Yes	
Protection ⁽¹⁾	a – g	
VE.Bus communication port	For parallel, split phase and three phase operation, remote monitoring and system integration	
General purpose com. port ⁽⁶⁾	Yes, 2x	
Remote on-off	Yes	
Pollution Degree (PD) & Overvoltage Category (OVC)	PD: 2 & OVC III	
Ambient temperature range	-40 to +60°C (-40 - 140°F) fan assisted cooling	
Humidity (non-condensing)	max 95%	
ENCLOSURE		
Material & Colour	Steel, blue RAL 5012	
Protection category	IP21	
Battery-connection	2x M8 bolts	
120 VAC connection	35mm ² (2 AWG)	
Weight	29 kg (64 lb)	32 kg (70 lb)
Dimensions hwxwd	627 x 350 x 150 mm 4.7x13.8x5.9 inch	676x329x164 mm 26.6 x 13.0 x 6.5 inch
STANDARDS		
Listings	-	UL1741
Safety	EN-IEC 60335-1, EN-IEC 60335-2-29, CSA 22.2 107.1-16	
Emission, Immunity	EN 55014-1, EN 55014-2 EN-IEC 61000-3-2, EN-IEC 61000-3-3 IEC 61000-6-1, IEC 61000-6-2, IEC 61000-6-3	

MultiPlus-II 120V		24/5000/120-95	48/5000/70-95
1.	Protection key:	2.	Non-linear load, crest factor 3:1
a.	output short circuit	3.	Up to 75°F / 25°C ambient
b.	overload	4.	Switches off when no external Ac source available
c.	battery voltage too high	5.	Programmable relay which can be set for general alarm, DC under voltage or genset start/stop function. AC rating: 120V / 4A, DC rating: 4A up to 35VDC and 1A up to 60VDC
d.	battery voltage too low	6.	Use, for example, to communicate with a Lithium-Ion battery BMS
e.	temperature too high	7.	Dimensions of the not UL1741 certified model: 536 x 277 x 147 mm / 21.1 x 10.9 x 5.8 inch
f.	120 VAC on inverter output		
g.	input voltage ripple too high		

MultiPlus-II 120V 50/60Hz	12/4k/160-50
PowerControl & PowerAssist	Yes
Transfer switch	50A
Maximum AC input current	50A
INVERTER	
DC Input voltage range	9.5 - 17V
Output in inverter mode	Output voltage: 120VAC \pm 2% Frequency: 60Hz \pm 0.1% ⁽¹⁾
Continuous output power at 25°C	3.4kW
Continuous output power at 40°C	3.1kW
Continuous output power at 65°C	2.4kW
Time limited power 1 (cold start)	4.0kW/2h
Time limited power 2 (cold start)	4.5kW/30min
Peak power	6kW/2s
Maximum efficiency	93%
Zero load power	18W
Zero load power in AES mode	11W
Zero load power in Search mode	4W
CHARGER	
AC Input	Single phase: 90-140VAC 45 - 65Hz
Charge voltage 'absorption'	14.4V
Charge voltage 'float'	13.8V
Storage mode	13.2V
Maximum battery charge current ⁽³⁾	160A
Battery temperature sensor	Yes
GENERAL	
Auxiliary output ⁽⁴⁾	32A
External AC current sensor (optional)	100A
Programmable relay ⁽⁵⁾	Yes
Protection ⁽¹⁾	a - g
VE.Bus communication port	For parallel, split phase and three phase operation, remote monitoring and system integration
General purpose com. port ⁽⁶⁾	Yes, 2x

MultiPlus-II 120V 50/60Hz	12/4k/160-50
Remote on-off	Yes
Ambient temperature range	-40 to +65°C (-40 - 150°F) fan assisted cooling
Maximum humidity (non-condensing)	max 95%
ENCLOSURE	
Material & Colour	Steel, blue RAL 5012
Protection category	IP21
Battery-connection	2x2 M8 bolts
120 VAC connection	Screw terminals 13mm ² (6 AWG)
Weight	22 kg (49 lb)
Dimensions hwxwd	631 x 277 x 164 mm 24.8 x 10.9 x 6.5 inch
STANDARDS	
Listing	UL 458
Safety	EN-IEC 60335-1, EN-IEC 60335-2-29, CSA 22.2 107.1-16
Emission, Immunity	EN 55014-1, EN 55014-2 EN-IEC 61000-3-2, EN-IEC 61000-3-3 IEC 61000-6-1, IEC 61000-6-2, IEC 61000-6-3
<ol style="list-style-type: none"> 1. Can be adjusted to 50Hz 2. Protection key: <ol style="list-style-type: none"> a. output short circuit b. overload c. battery voltage too high d. battery voltage too low e. temperature too high f. 120VAC on inverter output g. input voltage ripple too high 3. Non-linear load, crest factor 3:1 4. Up to 75°F / 25°C ambient 5. Programmable relay, which can be set for general alarm, DC under voltage or genset start/stop function. AC rating: 120V / 4A, DC rating: 4A up to 35VDC and 1A up to 60VDC 6. Use, for example, to communicate with a Lithium-Ion battery BMS 	

8. Appendix

8.1. A: Connection overview

MultiPlus-II 3000VA & 5000VA 120V

A	Load connection. AC-OUT-1. Left to right: N (neutral), PE (earth/ground), L (phase)
B	Load connection. AC-OUT-2. Left to right: N (neutral), PE (earth/ground), L (phase)
C	AC input: Left to right: N (neutral), PE (earth/ground), L (phase)
D	Alarm contact: (left to right) NO, NC, COM.
E	Push button A – To perform a startup without assistants.
F	Primary ground connection M6 (PE).
G	Trickle charge positive terminal (12V and 24V models only)
H	M8 battery positive connection.
I	M8 battery minus connection.
J	switch: 1=On, 0=Off, =charger only
K	Connector for remote switch: Short to switch "on".
L	2x RJ45 VE-BUS connector for remote control and/or parallel / three-phase operation
M	External current sensor

Internal Current Sense

External Current Sense

To connect the current sensor, remove the wire bridge between the INT and COM terminals, connect the red sensor wire to the EXT terminal and connect the white sensor wire to the COM terminal.

N	<p>Terminal for: top to bottom:</p> <ol style="list-style-type: none"> 1. 12V 100mA 2. Programmable contact K1 open collector 70V 100mA 3. External ground relay + 4. External ground relay - 5. Aux input 1 + 6. Aux input 1 - 7. Aux input 2 + 8. Aux input 2 - 9. Temperature sense + 10. Temperature sense - 11. Battery voltage sense + 12. Battery voltage sense -
---	--

MultiPlus-II 4k 120V

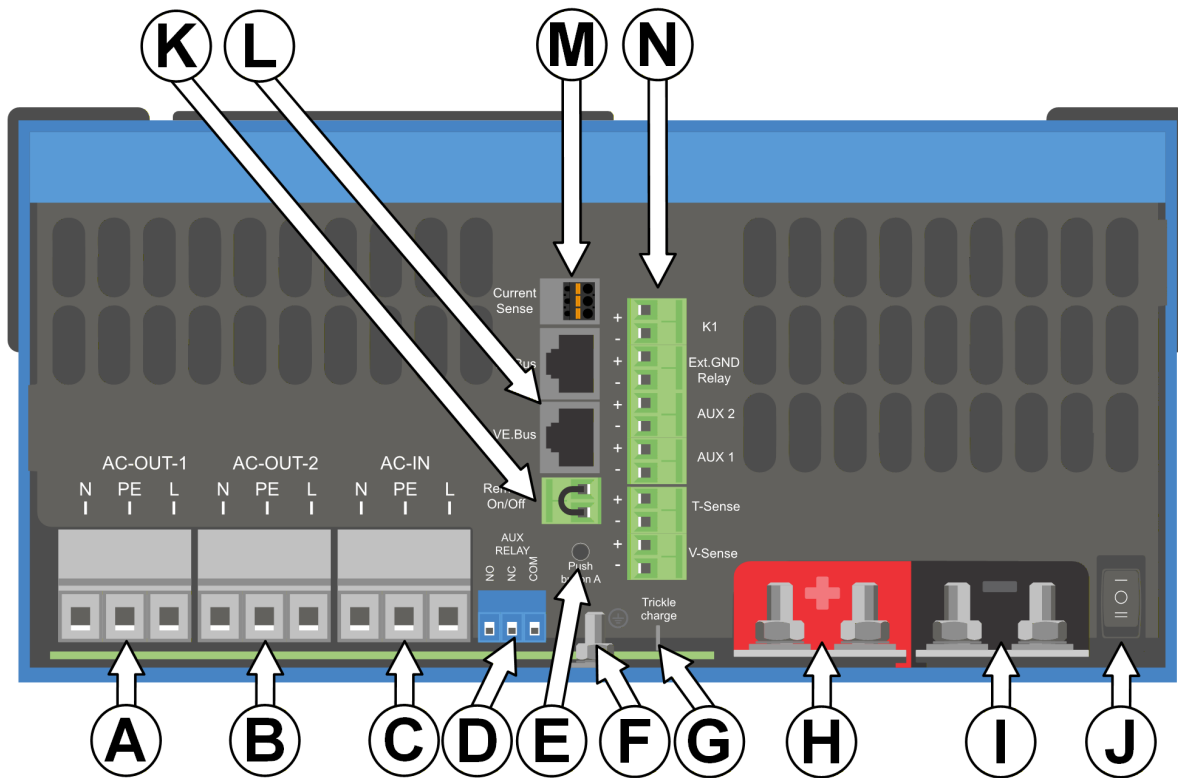

A	Load connection. AC-OUT-1. Left to right: N (neutral), PE (earth/ground), L (phase)
B	Load connection. AC-OUT-2. Left to right: N (neutral), PE (earth/ground), L (phase)
C	AC input: Left to right: N (neutral), PE (earth/ground), L (phase)
D	Alarm contact: (left to right) NO, NC, COM.
E	Push button A – To perform a startup without assistants.
F	Primary ground connection M6 (PE).
G	Trickle charge positive terminal (12V and 24V models only)
H	M8 battery positive connection.

I	M8 battery minus connection.
J	switch: 1=On, 0=Off, =charger only
K	Connector for remote switch: Short to switch "on".
L	2x RJ45 VE-BUS connector for remote control and/or parallel / three-phase operation
M	<p>External current sensor</p>  <p>To connect the current sensor, remove the wire bridge between the INT and COM terminals, connect the red sensor wire to the EXT terminal and connect the white sensor wire to the COM terminal.</p>
N	<p>Terminal for: top to bottom:</p> <ol style="list-style-type: none"> 1. 12V 100mA 2. Programmable contact K1 open collector 70V 100mA 3. External ground relay + 4. External ground relay – 5. Aux input 1 + 6. Aux input 1 – 7. Aux input 2 + 8. Aux input 2 – 9. Temperature sense + 10. Temperature sense – 11. Battery voltage sense + 12. Battery voltage sense -

8.2. B: Block diagram

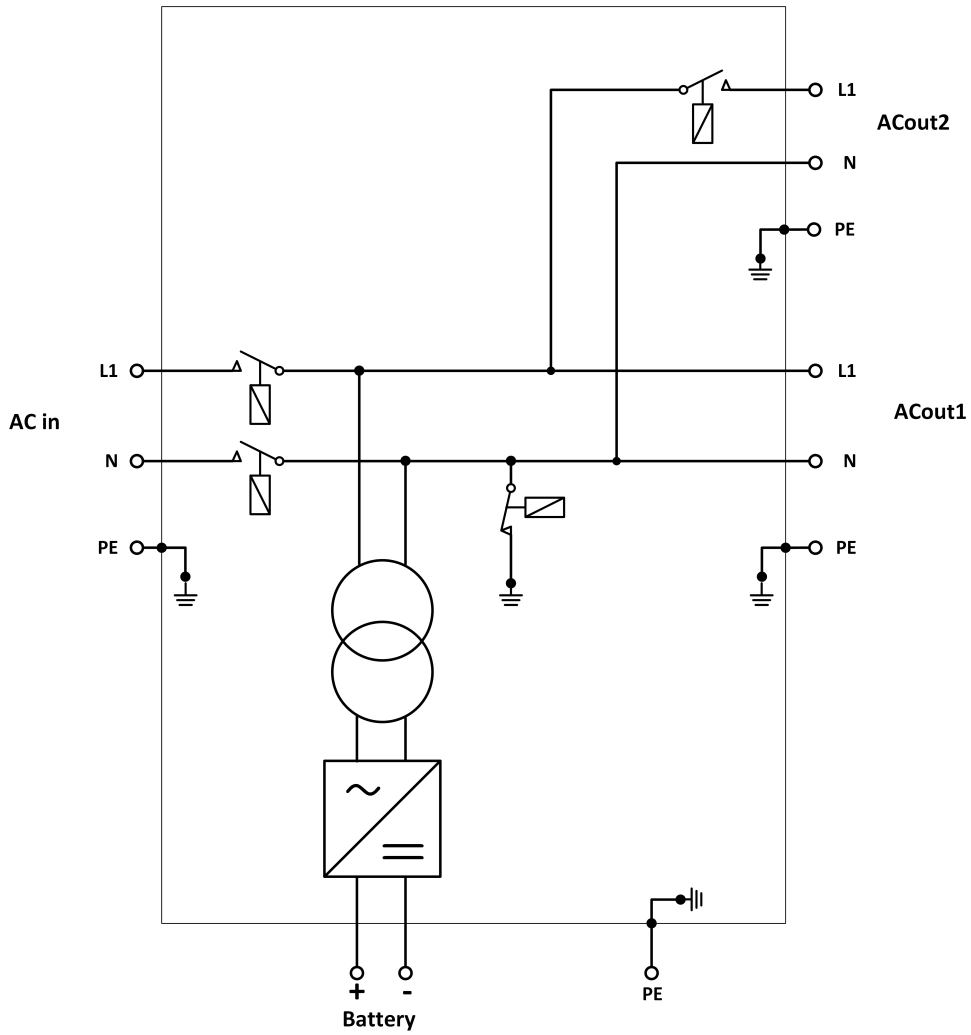

* See table in Chapter 4.2 'Recommended DC fuse'

8.3. C: Parallel connection diagram

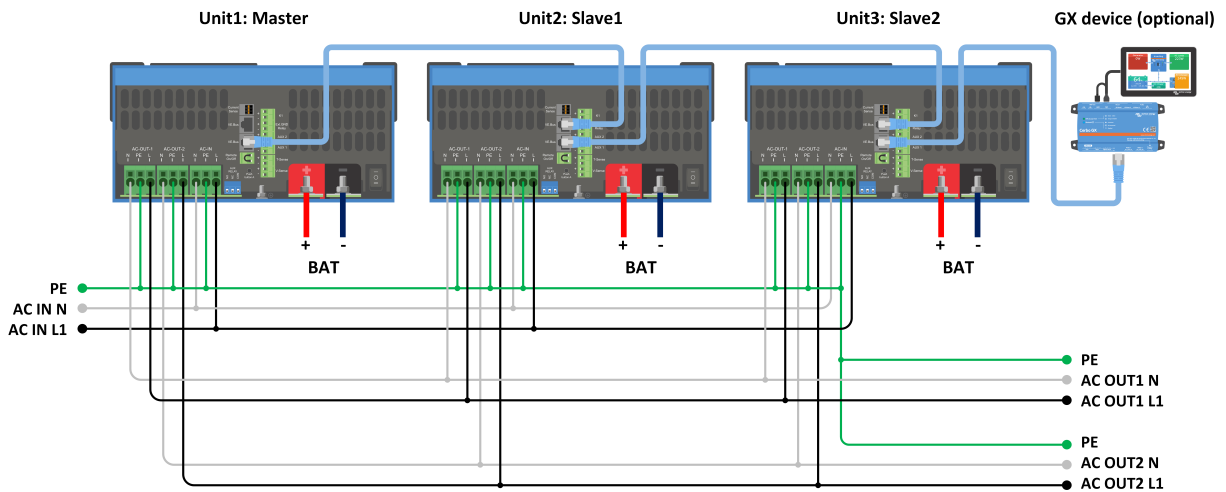

8.4. D: Three-phase connection diagram

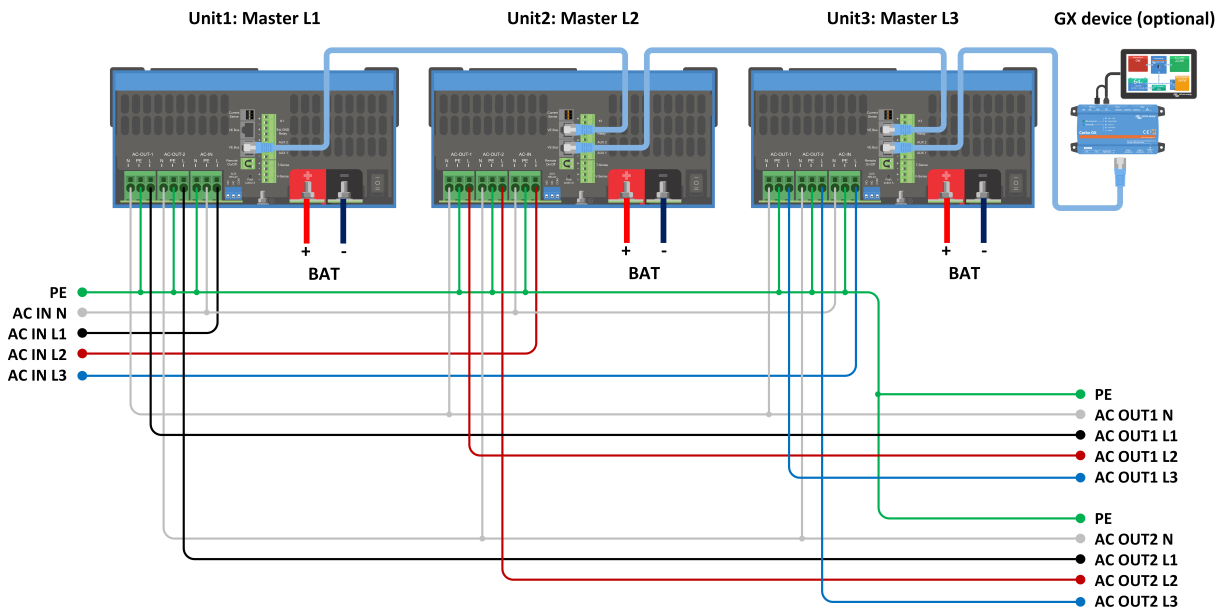

8.5. E: Charge algorithm

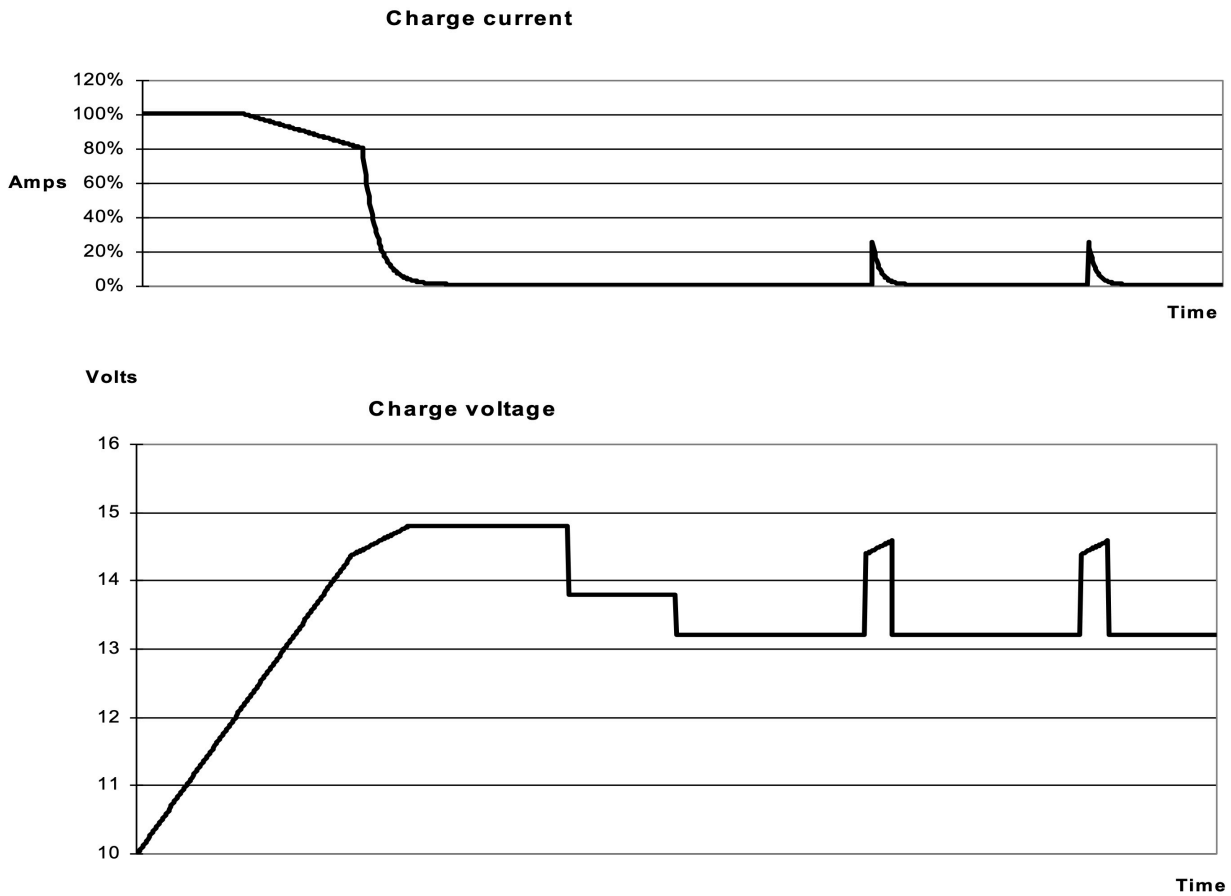

4-stage charging:

Bulk

Entered when charger is started. Constant current is applied until nominal battery voltage is reached, depending on temperature and input voltage, after which constant power is applied up to the point where excessive gassing starts (resp 14.4V, 28.8V or 57.6 temperature compensated).

Battery Safe

The applied voltage to the battery is raised gradually until the set Absorption voltage is reached. The Battery Safe Mode is part of the calculated absorption time.

Absorption

The absorption period is dependent on the bulk period. The maximum absorption time is the set Maximum Absorption time.

Float

Float voltage is applied to keep the battery fully charged

Storage

After one day of float charge the output voltage is reduced to storage level. This is 13.2 V for 12V, 26.4V for 24V and 52.8V for 48V batteries. This will reduce water loss to a minimum when the battery is stored for the winter season. After an adjustable time (default = 7 days) the charger will enter Repeated Absorption-mode for an adjustable time (default = one hour) to 'refresh' the battery.

8.6. F: Temperature compensation chart

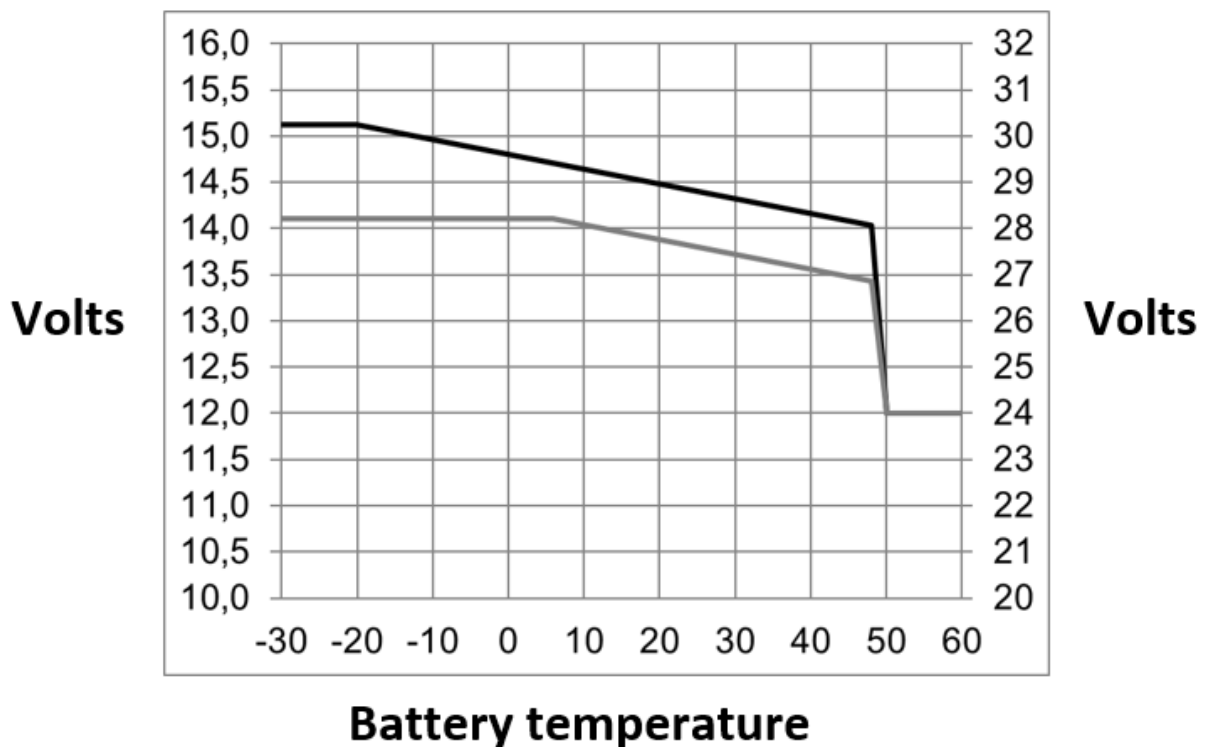

The above chart displays the default output voltages for Float and Absorption at 25 °C for 12 and 24V battery banks. For a 48V battery bank, multiply the 24V voltages by 2.

Reduced Float voltage follows the Float voltage, and Raised Absorption voltage follows the Absorption voltage.

Temperature compensation does not apply in adjust mode.

8.7. G: Enclosure dimensions

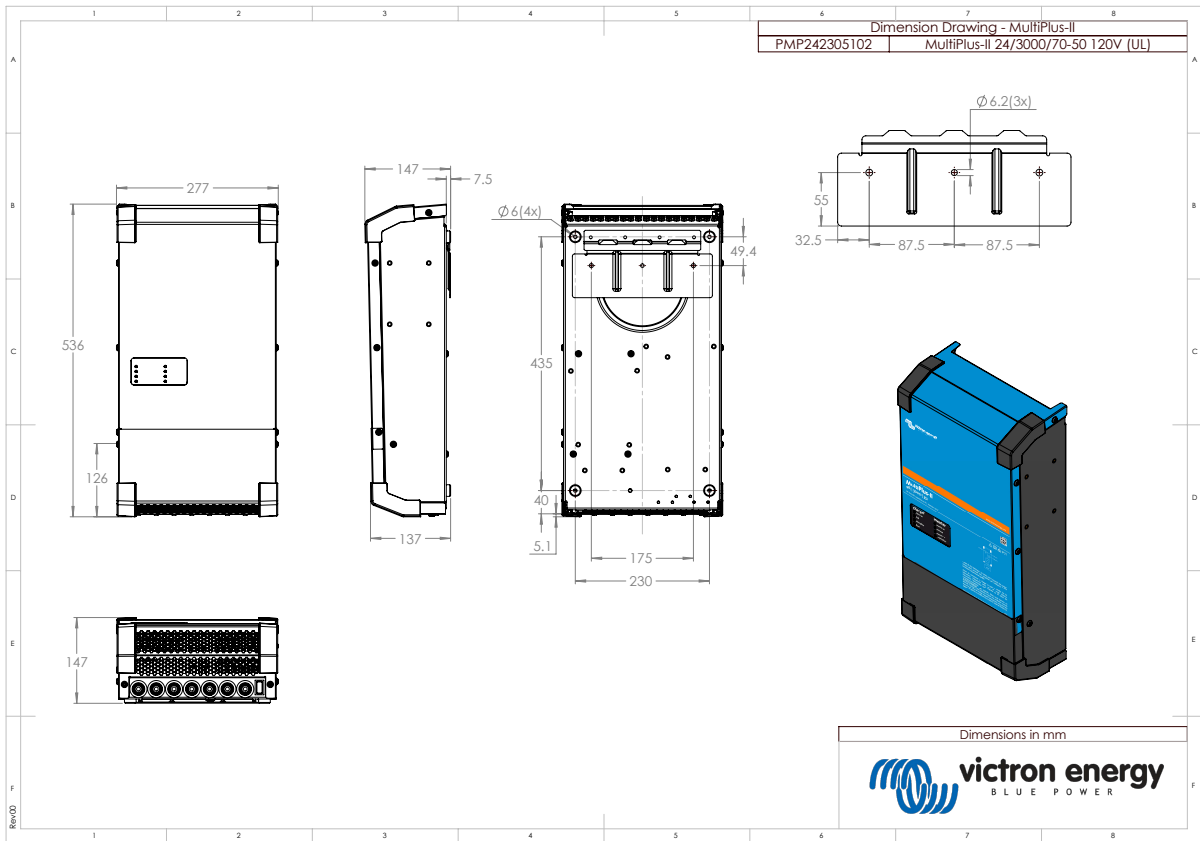
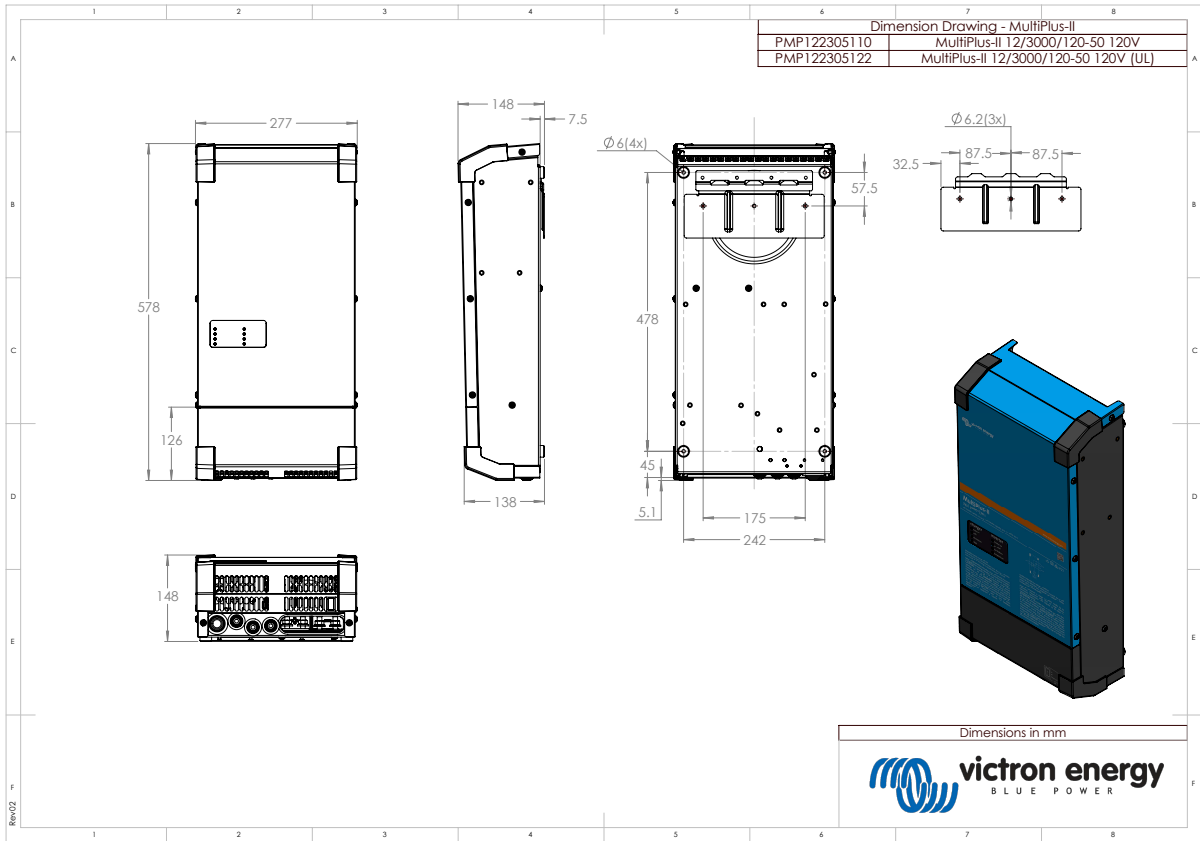

MultiPlus-II 120V

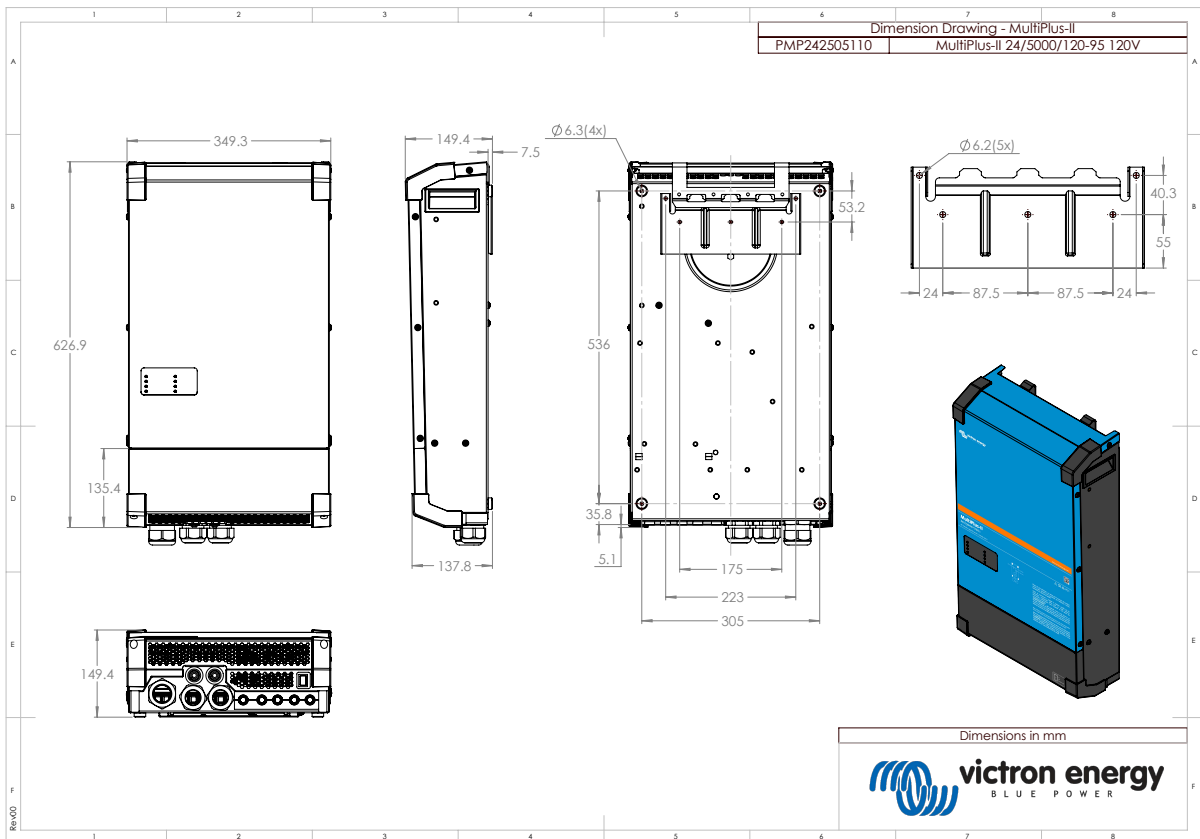
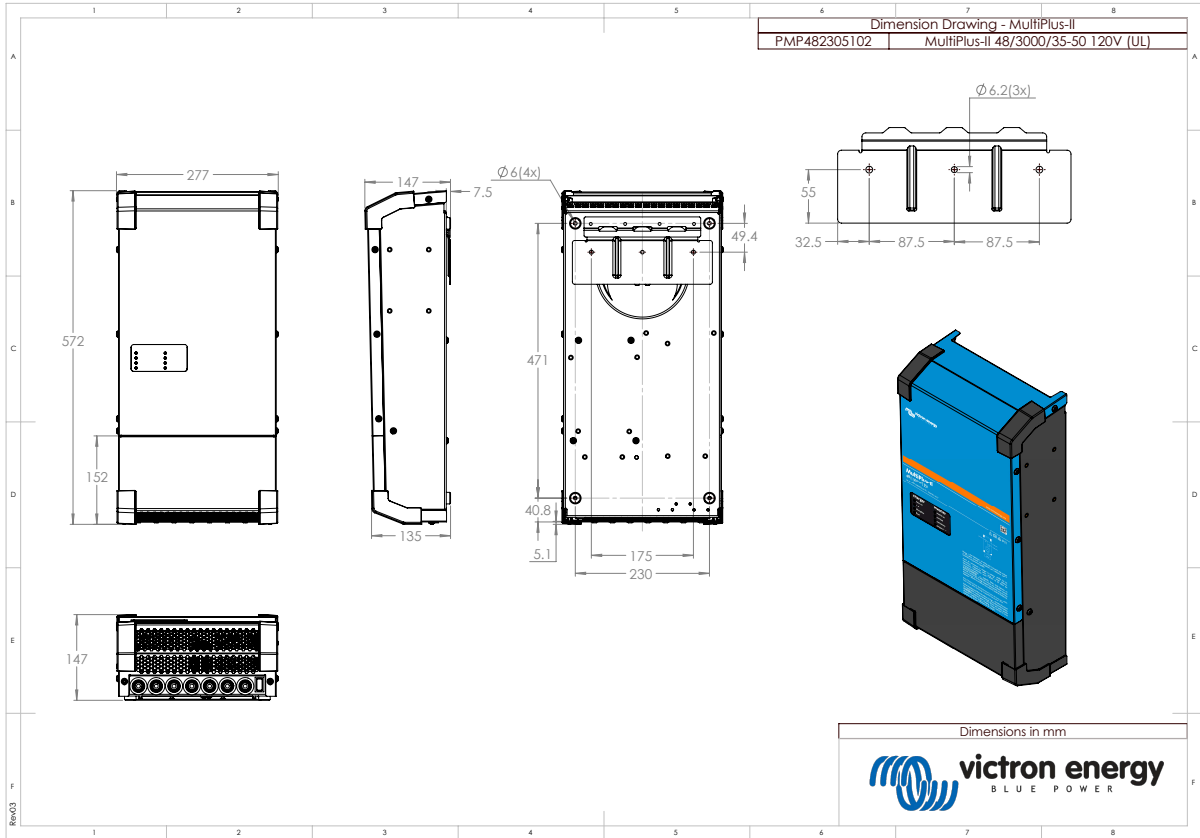

MultiPlus-II 120V

